

ALU15 3m

9016

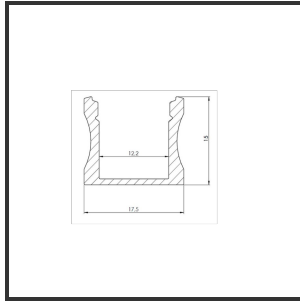

Dimensions	3000x17,5x15	Material Housing	Aluminium
Color	RAL9016	Mounting Type	Plafond

Reference : 000001788

Product Description

Rectangular construction profile very suitable for indoor applications. The profile's sleek appearance and optimum light emission make it very widely applicable. Easy and quick installation thanks to the compact design and mounting brackets. Because the LED strip is further away from the diffuser, there is an even light radiation. The light dots are therefore less visible. Profile made of anodised aluminium. Thermal and mechanical protection of LED strips. This profile is suitable for single LED strips and LED modules. Available as recessed and surface mounted profile. Dimensions: 3000x17.5x15mm. Optional: Mounting clips, end caps, connectors & RAL colour. Diffuser as end cap is available in 30° and 60°.