

# CIRCLE DOWN 120

9016 3000K/CRI80 triac 6m

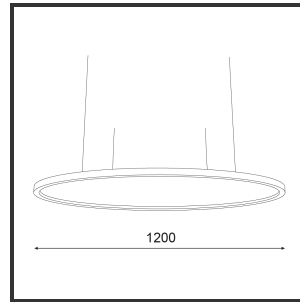
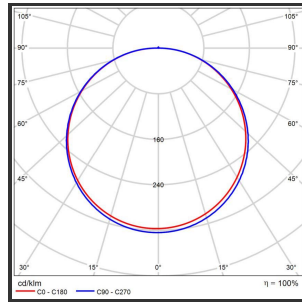

Beamangle	100°	Led type	SMD
CIE Flux Codes	44 75 94 99 100	Lumen Maintenance	L80B10 bij 50.000
Colour Deviation (SDCM)	3	Lumen/W	135lm/W
Colour Temperature	3000K	Luminous flux of luminaire	7360lm
CRI	80	Material Housing	Aluminium
Dim	Triac	Material Lens/Reflector/Diffusor	Silicone
Dimensions	Ø1200x35x35	Max. connected Load	80W
Energy Efficiency Class	D	Mounting Type	Suspension
Forward Voltage	24V	PF	0,92
Frequency	50-60Hz	Suspension Length	6m
IK	07	UGR	<24
IP	IP33	Connected Voltage	220-240V
Color	RAL9016	Weight	5kg

Reference : 000060730

## Product Description

De Cirkel Down, met indrukwekkende finesse zorgt deze eyecatcher voor de architecturale touch van elke ruimte. Door de sublieme afronding van het profiel en de diffusor is de Circle een echt statement piece. Mix-and-match de verschillende types voor een speels effect. Beschikbaar in 4 groottes: 80 (800x35x35, 60W), 120 (1200x35x35, 80W), 150 (1500x35x35, 105W) en 300 (3000x35x35, 210W). Dit gependeld cilindrisch armatuur is te pendelen op 1,5m of 6m. Beschikbaar in 27000K, 3000K of 4000K. Standaard on/off. Dimbaar in Dali, Dali push, Triac en 1-10V, deze kunnen extern weggewerkt worden of in de rozet voorzien worden. Beschikbaar in 9005, 9010 en 9016.